

# SG 7600

---

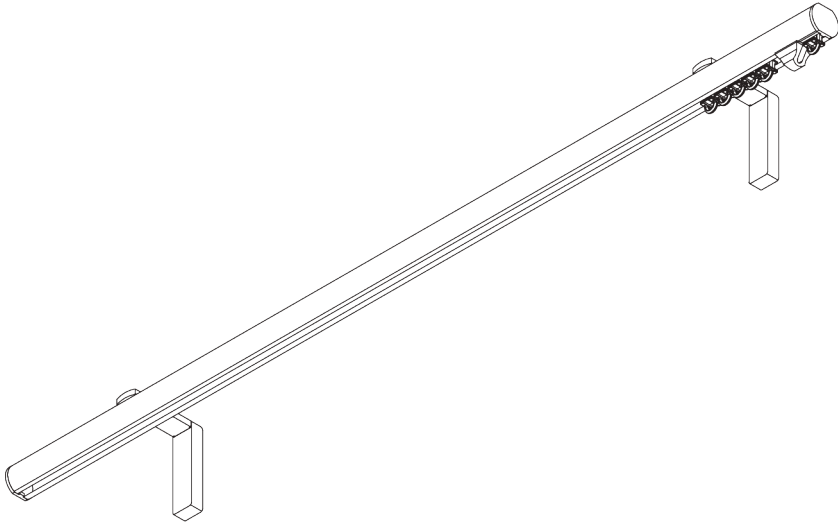
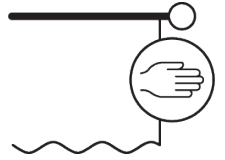

## PRODUCT INFORMATION

- **Operation:** hand
- **Range:** S
- **Fitting:** ceiling, wall
- **Colours:** white RAL 9016, various colours / finishes
- **Fabrics:** refer to Silent Gliss fabric collection

### **Features:**

- 2-component (2C) glider technology
- Wave (2C)
- Matching endcaps and brackets / bracket covers
- Range of decorative finials
- Bendable

# SYSTEM SPECIFICATIONS

## A. PROFILE

Profile and bending information

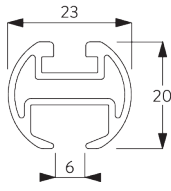

SG 11606

Profile

Radius:  
✓ 15 cm, 20 cm, >25 cm

## B. HOW TO MEASURE

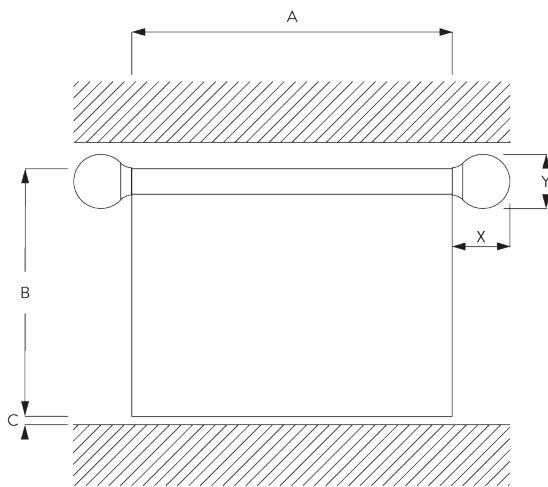

A: System width without finials







B: System height

C: Distance between floor and fabric

X: Finial width

Y: Finial height

## Finial Measurements

		23 mm	
		X	Y
	SG 11602	2	23
	SG 11621	8	27
	SG 11622	14	38
	SG 11726	49	46
	SG 11727	89	37
	SG 11728	20	69
	SG 11729	18	46

# FITTING

## A. FITTING INFORMATION

For detailed fitting information, visit the *Silent Gliss* website.

### Fixing points

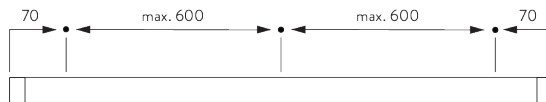

## B. CEILING FITTING

### Top fix bracket SG 11668

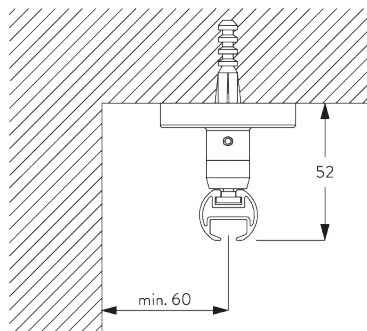

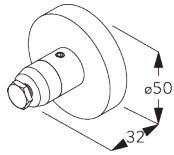

**SG 11668**

*Top fix bracket*

**Mini hanger SG 6175**

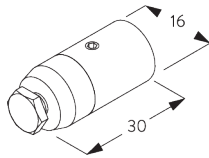
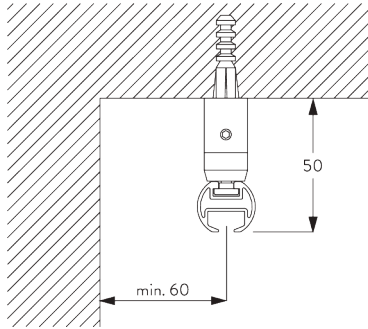

**SG 6175**

*Mini hanger*

**C. WALL FITTING**

**Smart Fix**

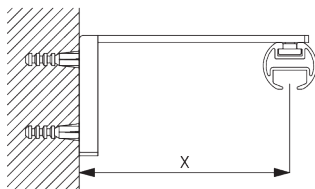

**Smart Fix with slot SG 11206 - SG 11208 and SG 6141:**

Screw SG 10492 (M4x8) needed.

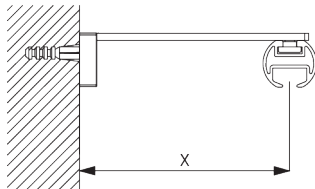

**Square Smart Fix with slot SG 11216 - SG 11218 and SG 6141:**

Screw SG 10492 (M4x8) needed.

<b>Smart Fix</b>	<b>X mm</b>
SG 11206 / SG 11216	51
SG 11207 / SG 11217	71
SG 11208 / SG 11218	91

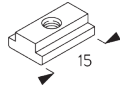

**SG 6141**  
Clamping piece



**SG 10492**  
Pan head screw M4x8

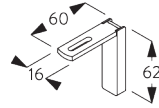

**SG 11206**  
Smart Fix with slot 60 mm

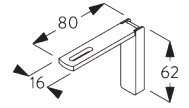

**SG 11207**  
Smart Fix with slot 80 mm

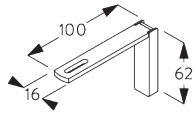

**SG 11208**  
Smart Fix with slot 100 mm

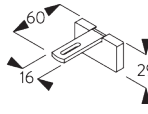

**SG 11216**  
Square Smart Fix with slot 60 mm

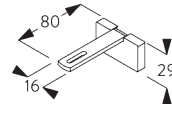

**SG 11217**  
Square Smart Fix with slot 80 mm

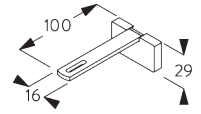

**SG 11218**  
Square Smart Fix with slot 100 mm

## Fillet Bracket SG 11669

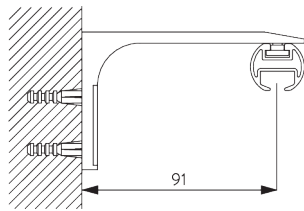

Screw SG 10492 (M4x8) needed.  
Recommended for straight systems only.

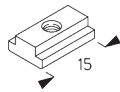

**SG 6141**  
Clamping piece



**SG 10492**  
Pan head screw M4x8

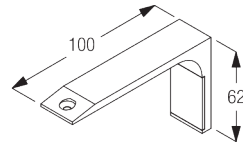

**SG 11669**  
Fillet bracket

# DESIGN & SYSTEM OPTIONS

## A. ENDCAPS



SG 11602



SG 11621



SG 11622

### Endcaps:

- SG 11602 Flush endcap 23 mm
- SG 11621 Stud endcap 23 mm
- SG 11622 Design endcap 23 mm

### Please note:

- Without finials, poles are supplied as standard with flush fitting endcaps SG 11602 (left).
- Alternatively, stud endcaps SG 11621 can be selected.

## B. FINIALS

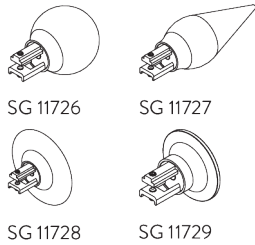

Finials are decorative elements that fit on at the end of the pole:

- SG 11726 Ball end 23 mm
- SG 11727 Spear 23 mm
- SG 11728 Ellipse 23 mm
- SG 11729 Taper 23 mm

## C. WAVE

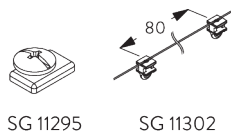
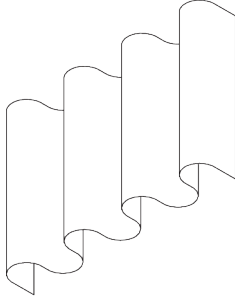

Standard components:

- SG 11295 End stop
- SG 11302 Wave 2C glider cord 80 mm

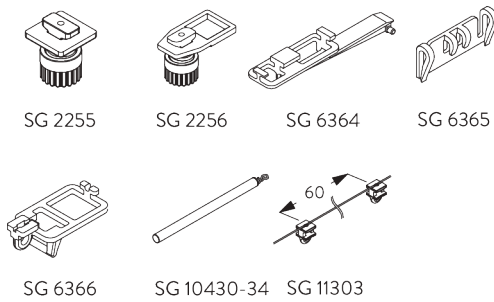

Optional components (min. Radius >25 cm):

- SG 2255 Brake
- SG 2256 Brake
- SG 6364 Wave extension
- SG 6365 Wave hanger
- SG 6366 Wave carrier for draw rod
- SG 10430-34 Draw rod
- SG 11303 Wave 2C glider cord 60 mm

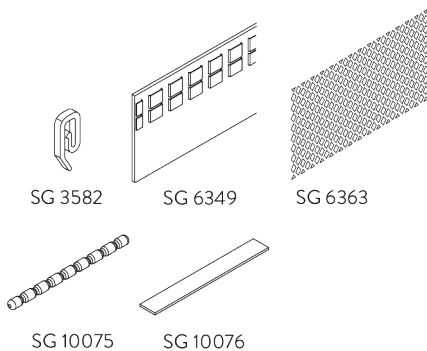

Curtain components:

- SG 3582 Hook
- SG 6349 Wave curtain tape
- SG 6363 Wave top hemming tape
- SG 10075 Lead weight 50 gr/m
- SG 10076 Fabric weigh

Wave stack depth - 2C glider cord (standard components)

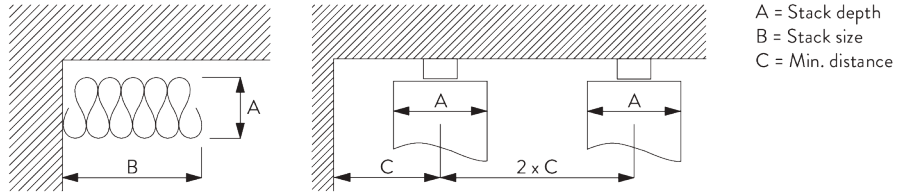

2C Glider cord SG 11302	Pockets between hooks	Approx. curtain fullness	Stack depth A	Stack size B*	Min distance C
80	6	~2.1	140	180 per metre of track	90
80	7	~2.3	160	180 per metre of track	100

2C Glider cord SG 11303	Pockets between hooks	Approx. curtain fullness	Stack depth A	Stack size B*	Min distance C
60	4	~2.1	100	230 per metre of track	70
60	5	~2.3	120	230 per metre of track	80

\*Stack size B when using optional extension arm SG 6364 increases by 95 mm per curtain stack!

# PARTS

## A. STANDARD PARTS



**SG 6065**

End stop

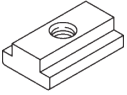

**SG 6141**

Clamping piece

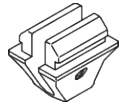

**SG 6245**

Spring stop

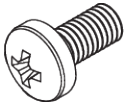

**SG 10492**

Pan head screw M4x8

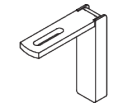

**SG 11206**

Smart Fix with slot 60 mm



**SG 11300**

2C glider

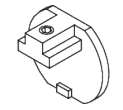

**SG 11602**

Flush end cap 23 mm



**SG 11606**

Profile

## B. OPTIONAL PARTS

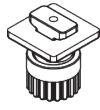

**SG 2255**

Brake

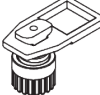

**SG 2256**

Brake



**SG 3582**

Hook



**SG 3599**

Hook

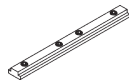

**SG 6173**

Connection bridge

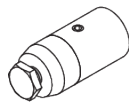

**SG 6175**

Mini hanger



**SG 6349**

Wave curtain tape



**SG 6363**

Wave top hemming tape

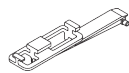

**SG 6364**

Wave extension

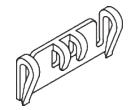

**SG 6365**

Wave hanger

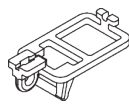

**SG 6366**

Wave carrier for draw rod

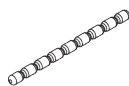

**SG 10075**

Lead weight 50 g/m

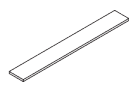

**SG 10076**

Fabric weight



**SG 10430**

Draw rod 50 cm

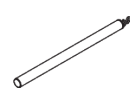

**SG 10431**

Draw rod 75 cm

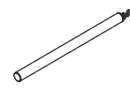

**SG 10432**

Draw rod 100 cm

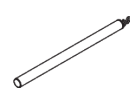

**SG 10433**

Draw rod 125 cm

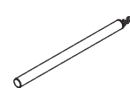

**SG 10434**

Draw rod 150 cm

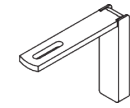

**SG 11207**

Smart Fix with slot 80 mm

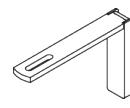

**SG 11208**

Smart Fix with slot 100 mm

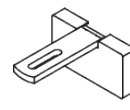

**SG 11216**

Square Smart Fix with slot 60 mm

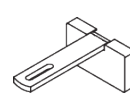

**SG 11217**

Square Smart Fix with slot 80 mm

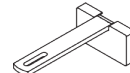

**SG 11218**

Square Smart Fix with slot 100 mm

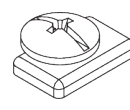

**SG 11295**

End stop



**SG 11301**

2C glider on strip

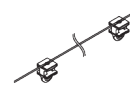

**SG 11302**

Wave 2C glider cord 80 mm

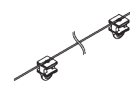

**SG 11303**

Wave 2C glider cord 60 mm



**SG 11621**

Stud endcap 23 mm



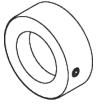

---

**SG 11622**  
*Design endcap 23 mm*

---



---

**SG 11668**  
*Top fix bracket*

---

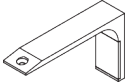

---

**SG 11669**  
*Fillet bracket*

---

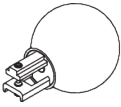

---

**SG 11726**  
*Ball end 23 mm*

---

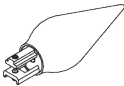

---

**SG 11727**  
*Spear 23 mm*

---

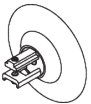

---

**SG 11728**  
*Ellipse 23 mm*

---

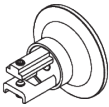

---

**SG 11729**  
*Taper 23 mm*

---





