

SG 6243

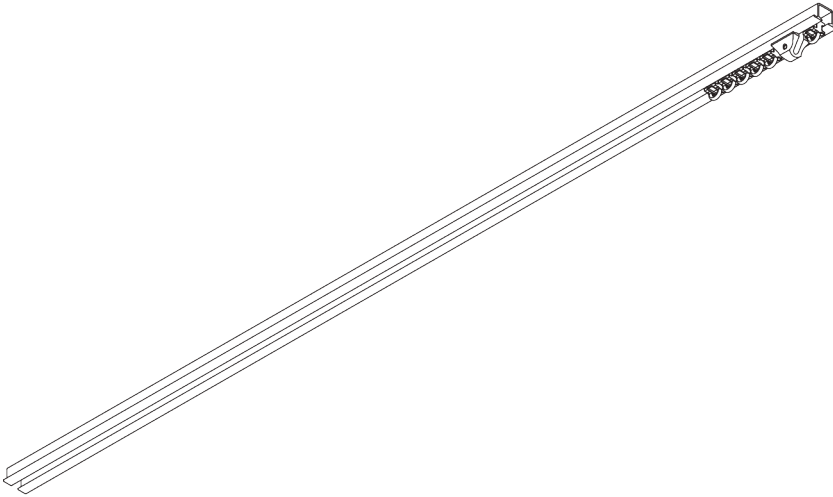

PRODUCT INFORMATION

- **Operation:** hand
- **Range:** S - M
- **Fitting:** recess
- **Colours:** white RAL 9016 or anodised aluminum, special colours possible
- **Fabrics:** refer to Silent Gliss fabric collection

Features:

- 2-component (2C) glider technology
- Wave (2C)
- Bendable
- Pre-drilled profile

SYSTEM SPECIFICATIONS

A. PROFILE

Profile and bending information

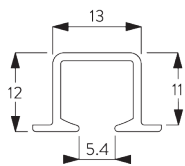

SG 6243p

Profile

Radius:
20 cm, >25 cm

B. HOW TO MEASURE

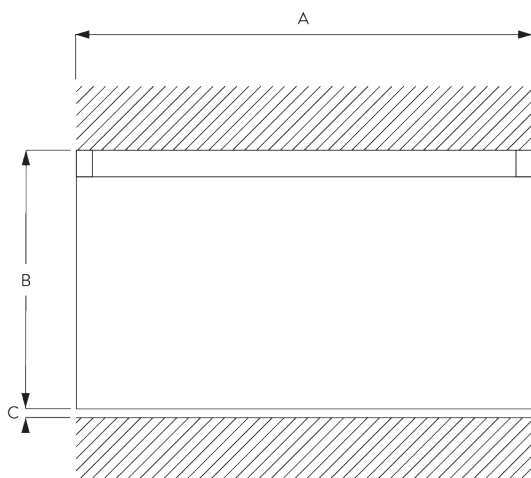

A: System width

B: System height

C: Distance between floor and fabric

FITTING

A. FITTING INFORMATION

Fixing points

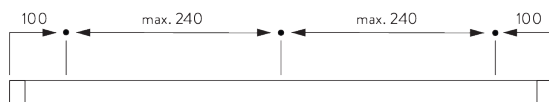

For detailed fitting information, visit the [Silent Gliss website](#).

B. RECESS FITTING

Direct into wood

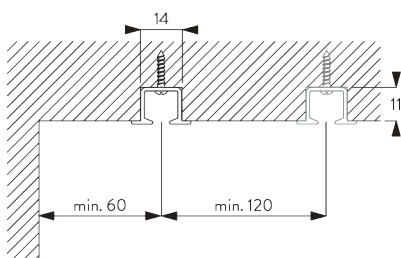

Recess channel: 11 x 14 mm

SYSTEM OPTIONS

A. WAVE

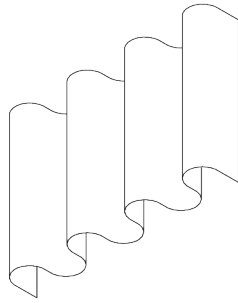

SG 11295

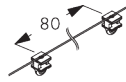

SG 11302



SG 2255



SG 2256

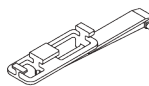

SG 6364



SG 6365

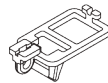

SG 6366

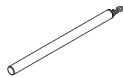

SG 10430-34

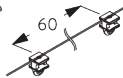

SG 11303

Standard components:

- SG 11295 End stop
- SG 11302 Wave 2C glider cord 80 mm

Optional components (min. radius >25 cm):

- SG 2255 Brake
- SG 2256 Brake
- SG 6364 Wave extension
- SG 6365 Wave hanger
- SG 6366 Wave carrier for draw rod
- SG 10430-34 Draw rod
- SG 11303 Wave 2C glider cord 60 mm



SG 3582

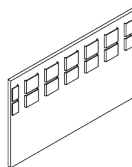

SG 6349

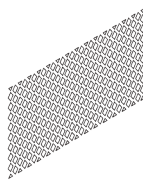

SG 6363

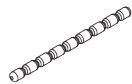

SG 10075



SG 10076

Curtain components:

- SG 3582 Hook
- SG 6349 Wave curtain tape
- SG 6363 Wave top hemming tape
- SG 10075 Lead weight 50 gr/m
- SG 10076 Fabric weight

Wave stack depth - 2C glider cord (standard components)

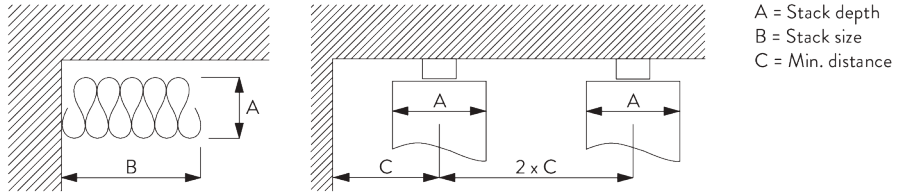





| 2C Glider cord SG 11302 | Pockets between hooks | Approx. curtain fullness | Stack depth A | Stack size B* | Min distance C |
|----------------------------|--------------------------|-----------------------------|------------------|---------------------------|-------------------|
| 80 | 6 | ~2.1 | 140 | 180 per metre of track | 90 |
| 80 | 7 | ~2.3 | 160 | 180 per metre of track | 100 |

| 2C Glider cord SG 11303 | Pockets between hooks | Approx. curtain fullness | Stack depth A | Stack size B* | Min distance C |
|----------------------------|--------------------------|-----------------------------|------------------|---------------------------|-------------------|
| 60 | 4 | ~2.1 | 100 | 230 per metre of track | 70 |
| 60 | 5 | ~2.3 | 120 | 230 per metre of track | 80 |











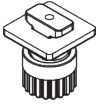

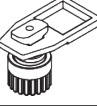



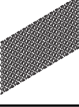
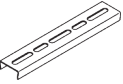
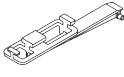

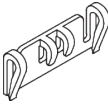
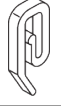
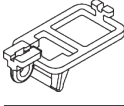
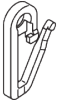
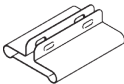
*Stack size B when using optional extension arm SG 6364 increases by 150 mm per curtain!

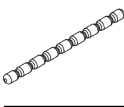
PARTS

A. STANDARD PARTS

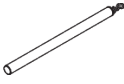
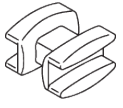
| | |
|---|--|
|  | SG 6065 End stop |
|  | SG 6086 Spring stop |
|  | SG 6243p Profile |
|  | SG 10717 Countersunk head screw 2.2x19 |
|  | SG 11300 2C glider |

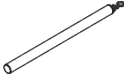
B. OPTIONAL PARTS

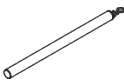
| | | | |
|---|-------------------------------------|---|---|
|  | SG 2255 Brake |  | SG 6240 Roller |
|  | SG 2256 Brake |  | SG 6283 Roller |
|  | SG 3012 Hook |  | SG 6349 Wave curtain tape |
|  | SG 3020 Hook |  | SG 6363 Wave top hemming tape |
|  | SG 3067 Connection bridge |  | SG 6364 Wave extension |
|  | SG 3581 Hook |  | SG 6365 Wave hanger |
|  | SG 3582 Hook |  | SG 6366 Wave carrier for draw rod |
|  | SG 3598 Eyelet |  | SG 7002 Profile protector |
|  | SG 6053 Spring stop |  | SG 10075 Lead weight 50 g/m |
|  | SG 6057 Glider |  | SG 10076 Fabric weight |
|  | SG 6064 End stop |  | SG 10430 Draw rod 50 cm |
|  | SG 6082 Glider |  | SG 10431 Draw rod 75 cm |
|  | SG 6094 Roller |  | SG 10432 Draw rod 100 cm |
|  | SG 6098 Roller |  | SG 10433 Draw rod 125 cm |

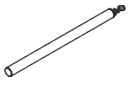

SG 10434

Draw rod 150 cm

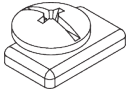

SG 11295

End stop



SG 11301

2C glider on strip

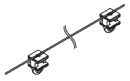

SG 11302

Wave 2C glider cord 80 mm

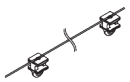

SG 11303

Wave 2C glider cord 60 mm

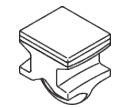

SG 11305

2C glider for direct sewing
