

SG 1070

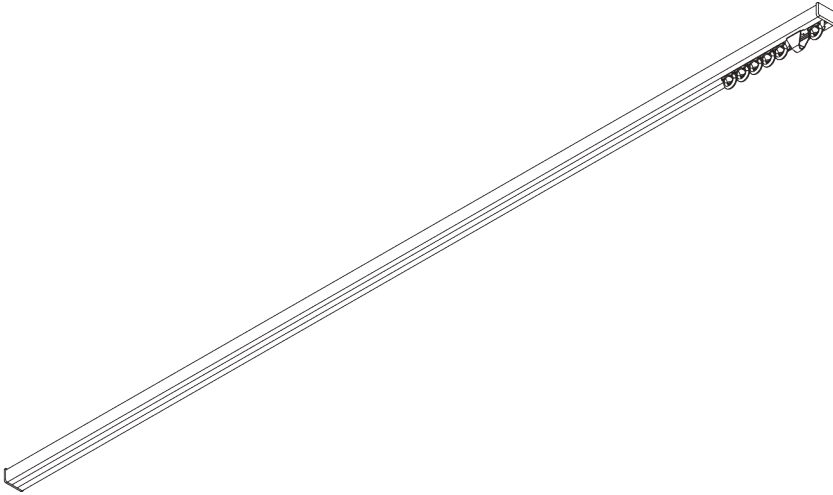

PRODUCT INFORMATION

- **Operation:** hand
- **Range:** S
- **Fitting:** ceiling
- **Colours:** white RAL 9016 or anodised aluminum, special colours possible
- **Fabrics:** refer to Silent Gliss fabric collection

Features:

- Bendable

SYSTEM SPECIFICATIONS

A. PROFILE

Profile and bending information

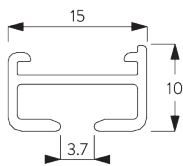

SG 1071

Profile

Radius:
8 cm, 12 cm, 16 cm,
>25 cm

B. HOW TO MEASURE

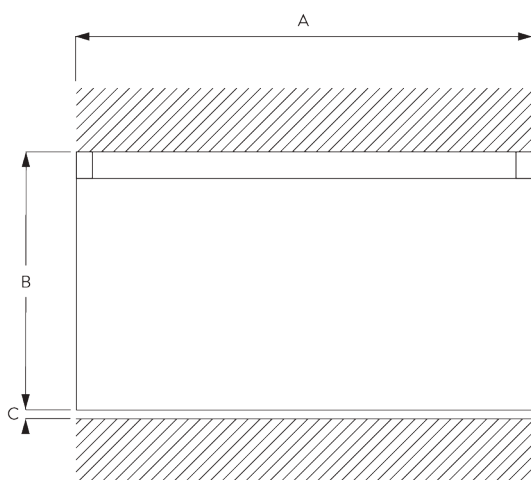

A: System width
B: System height
C: Distance between floor and fabric

FITTING

A. FITTING INFORMATION

For detailed fitting information, visit the [Silent Gliss website](#).

Fixing points

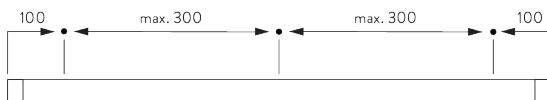

B. CEILING FITTING

Clamp SG 3060

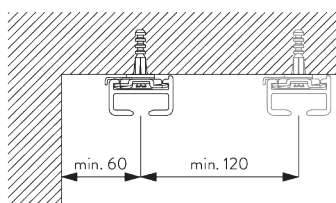

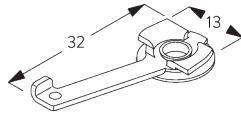

SG 3060

Clamp

PARTS

A. STANDARD PARTS

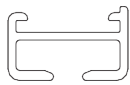

SG 1071

Profile

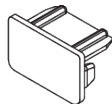

SG 1072

End cover

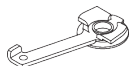

SG 3060

Clamp



SG 3070

End stop

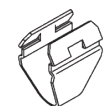

SG 3085

Spring stop



SG 3533

Glider

B. OPTIONAL PARTS



SG 3062

Connection bridge



SG 3534

Glider 3533 on strip



SG 3582

Hook

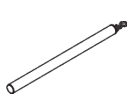

SG 10430

Draw rod 50 cm



SG 10431

Draw rod 75 cm



SG 10432

Draw rod 100 cm

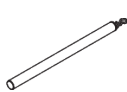

SG 10433

Draw rod 125 cm

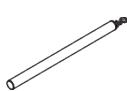

SG 10434

Draw rod 150 cm

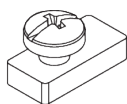

SG 11335

End stop