

SG 1060

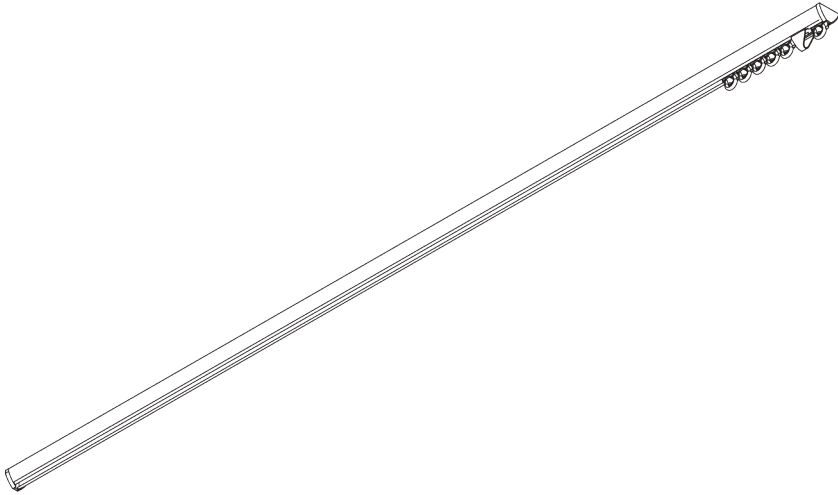

PRODUCT INFORMATION

- **Operation:** hand
- **Range:** S
- **Fitting:** ceiling
- **Colours:** white RAL 9016 or anodised aluminum, special colours possible
- **Fabrics:** refer to Silent Gliss fabric collection

Features:

- Bendable

SYSTEM SPECIFICATIONS

A. PROFILE

Profile and bending information

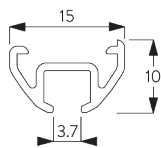

SG 1060p

Profile

Radius:
✓ 6 cm, 10 cm, 12 cm,
20 cm, >30 cm

B. HOW TO MEASURE

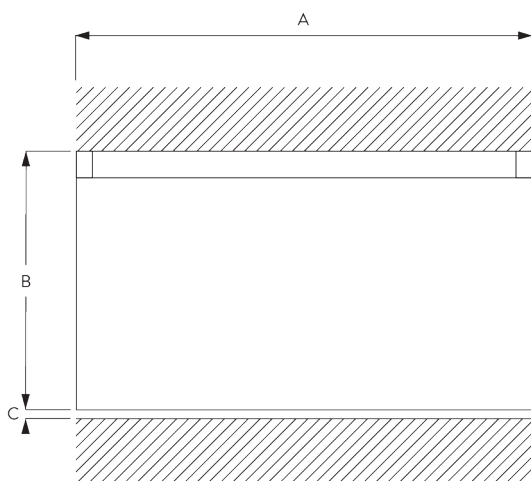

A: System width

B: System height

C: Distance between floor and fabric

FITTING

A. FITTING INFORMATION

For detailed fitting information, visit the [Silent Gliss website](#).

Fixing points

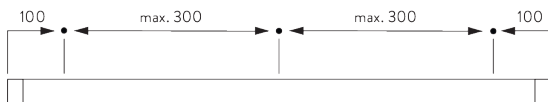

B. CEILING FITTING

Clamp SG 3060

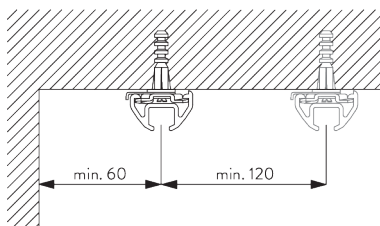

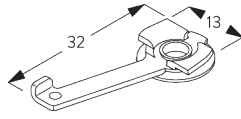

SG 3060

Clamp

PARTS

A. STANDARD PARTS

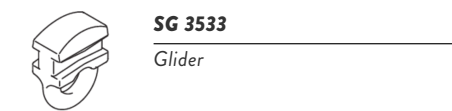
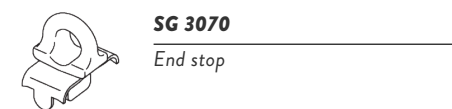
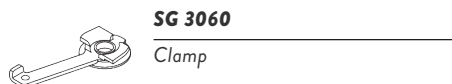
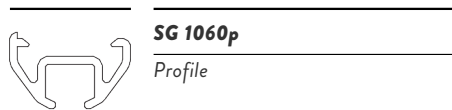

B. OPTIONAL PARTS

