

SG 1020

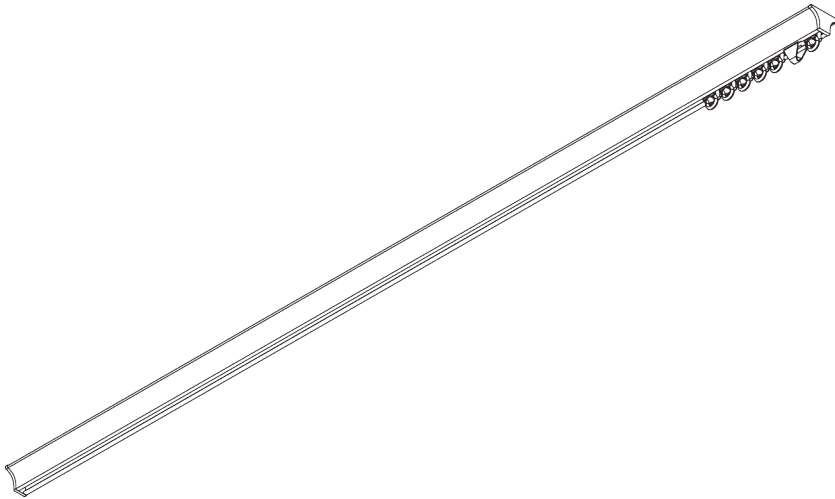

PRODUCT INFORMATION

- **Operation:** hand
- **Range:** S
- **Fitting:** ceiling
- **Colours:** white RAL 9016 or anodised aluminum, special colours possible
- **Fabrics:** refer to Silent Gliss fabric collection

Features:

- Symmetrical funnel design
- Bendable

SYSTEM SPECIFICATIONS

A. SYSTEM DIMENSIONS

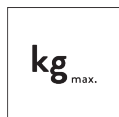

10 kg

B. PROFILE

Profile and bending information

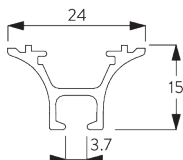

SG 6822

Profile Funnel



Radius: >27 cm

C. HOW TO MEASURE

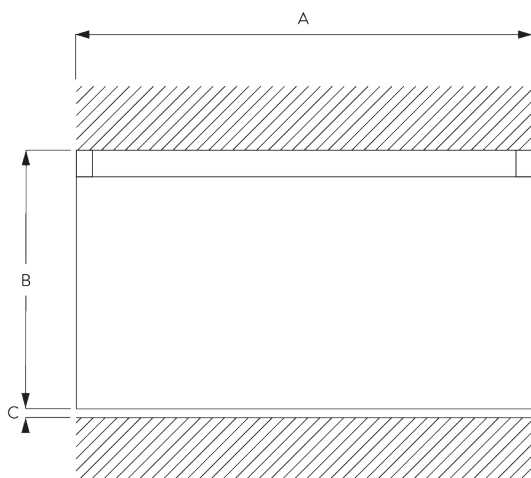

A: System width

B: System height

C: Distance between floor and fabric

FITTING

A. FITTING INFORMATION

For detailed fitting information, visit the [Silent Gliss website](#).

Fixing points

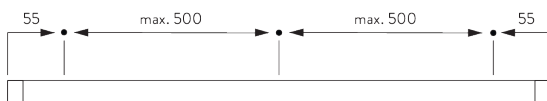

Fitting Tool

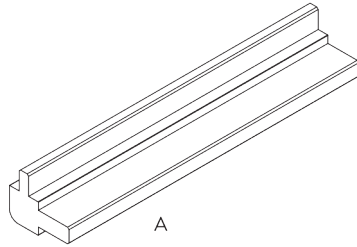

A: Funnel fitting tool SG 6827

For fitting / removing of the funnel profile.

B. CEILING FITTING

Clip SG 11236

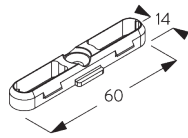
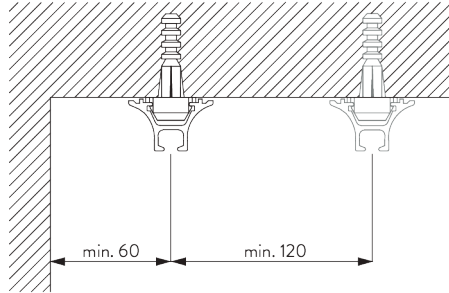

SG 11236

Clip

PARTS

A. STANDARD PARTS



SG 3070

End stop

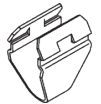

SG 3085

Spring stop



SG 3533

Glider



SG 6822

Profile Funnel



SG 6824

End cover

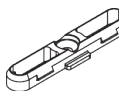

SG 11236

Clip

B. OPTIONAL PARTS



SG 3062

Connection bridge



SG 3534

Glider 3533 on strip



SG 3555

Hook



SG 3582

Hook



SG 10430

Draw rod 50 cm

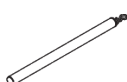

SG 10431

Draw rod 75 cm



SG 10432

Draw rod 100 cm

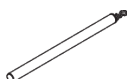

SG 10433

Draw rod 125 cm

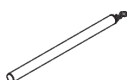

SG 10434

Draw rod 150 cm

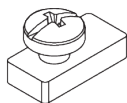

SG 11335

End stop