

# SG 1015

---

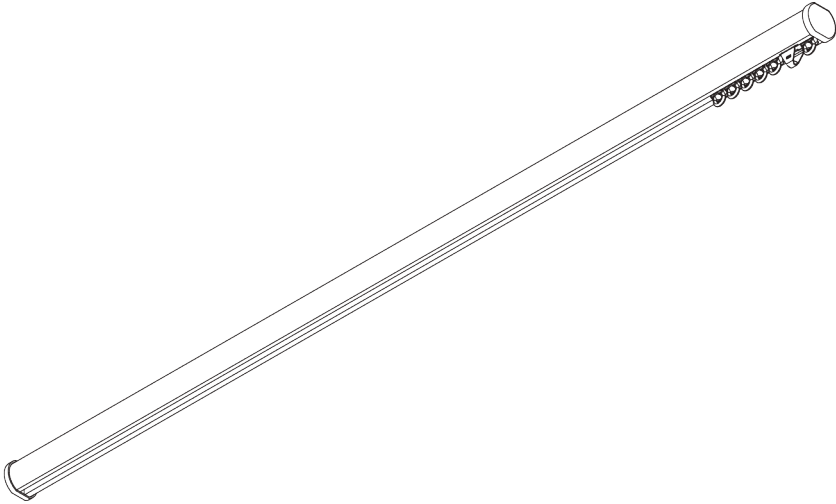

## PRODUCT INFORMATION

- **Operation:** hand
- **Range:** S
- **Fitting:** ceiling, wall
- **Colours:** white RAL 9016 or anodised aluminum, special colours possible
- **Fabrics:** refer to Silent Gliss fabric collection

### **Features:**

- Bendable

# SYSTEM SPECIFICATIONS

## A. PROFILE

Profile and bending information

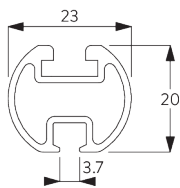

SG 1003p

Profile

Radius:  
✓ 15 cm, 20 cm, >25 cm

## B. HOW TO MEASURE

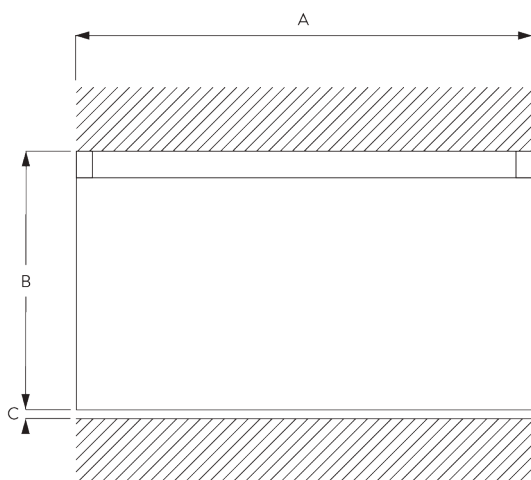

A: System width

B: System height

C: Distance between floor and fabric

# FITTING

## A. FITTING INFORMATION

Fixing points

For detailed fitting information, visit the [Silent Gliss website](#).

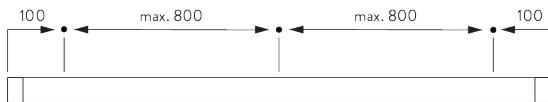

## B. CEILING FITTING

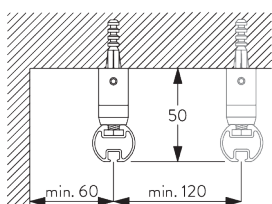

Mini hanger SG 6175

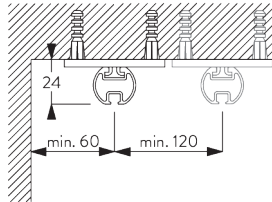

Bracket SG 6124

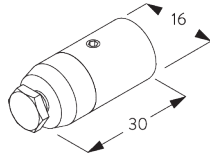

SG 6175  
Mini hanger

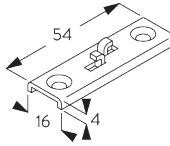

SG 6124  
Bracket

## C. WALL FITTING

### Smart Fix

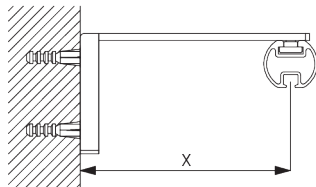

**Smart Fix with slot SG 11206 - SG 11208:**  
Screw SG 10492 (M4x8) needed.

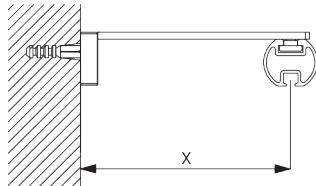

**Square Smart Fix with slot SG 11216 - SG 11218:**  
Screw SG 10492 (M4x8) needed.

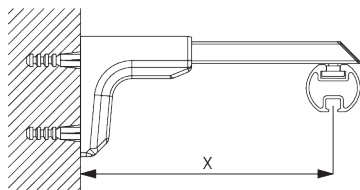

**Universal Smart Fix SG 11154 - SG 11156:**  
Screw SG 11131 (M4x6) needed.

Smart Fix	X mm
SG 11206 / SG 11216	33-51
SG 11207 / SG 11217	53-71
SG 11208 / SG 11218	73-91
SG 11154	102-130
SG 11155	132-160
SG 11156	182-210

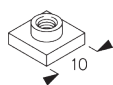

SG 6117  
Slot nut



SG 10492  
Pan head screw M4x8



SG 11131  
Pan head screw with flange  
M4x6

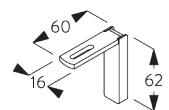

SG 11206  
Smart Fix with slot 60 mm  
M4x6

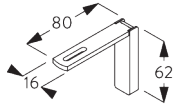

**SG 11207**  
Smart Fix with slot 80 mm

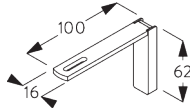

**SG 11208**  
Smart Fix with slot 100 mm

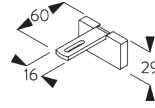

**SG 11216**  
Square Smart Fix with slot 60 mm

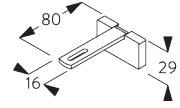

**SG 11217**  
Square Smart Fix with slot 80 mm

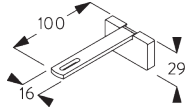

**SG 11218**  
Square Smart Fix with slot 100 mm

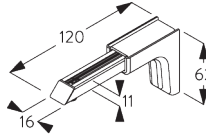

**SG 11154**  
Universal Smart Fix 120 mm

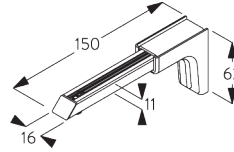



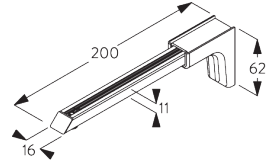

**SG 11155**  
Universal Smart Fix 150 mm





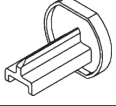

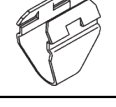
**SG 11156**  
Universal Smart Fix 200 mm

# PARTS

## A. STANDARD PARTS

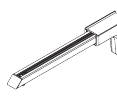
	<b>SG 1003p</b> Profile
	<b>SG 3014</b> End cover
	<b>SG 3070</b> End stop
	<b>SG 3085</b> Spring stop
	<b>SG 3533</b> Glider
	<b>SG 6175</b> Mini hanger

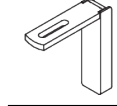
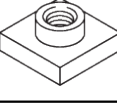
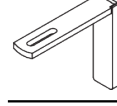
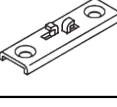
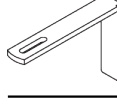
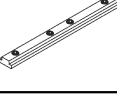
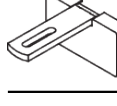
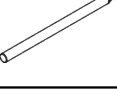
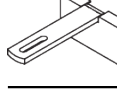
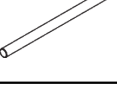
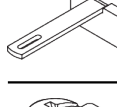
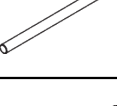
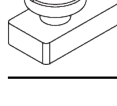
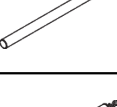
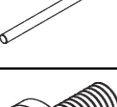
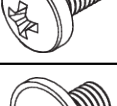
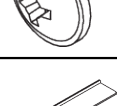
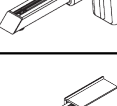
## B. OPTIONAL PARTS

	<b>SG 3534</b> Glider 3533 on strip		<b>SG 11156</b> Universal Smart Fix 200 mm
	<b>SG 3582</b> Hook		<b>SG 11206</b> Smart Fix with slot 60 mm
	<b>SG 6117</b> Slot nut		<b>SG 11207</b> Smart Fix with slot 80 mm
	<b>SG 6124</b> Bracket		<b>SG 11208</b> Smart Fix with slot 100 mm
	<b>SG 6173</b> Connection bridge		<b>SG 11216</b> Square Smart Fix with slot 60 mm
	<b>SG 10430</b> Draw rod 50 cm		<b>SG 11217</b> Square Smart Fix with slot 80 mm
	<b>SG 10431</b> Draw rod 75 cm		<b>SG 11218</b> Square Smart Fix with slot 100 mm
	<b>SG 10432</b> Draw rod 100 cm		<b>SG 11335</b> End stop
	<b>SG 10433</b> Draw rod 125 cm		
	<b>SG 10434</b> Draw rod 150 cm		
	<b>SG 10492</b> Pan head screw M4x8		
	<b>SG 11131</b> Pan head screw with flange M4x6		
	<b>SG 11154</b> Universal Smart Fix 120 mm		
	<b>SG 11155</b> Universal Smart Fix 150 mm		





