

SG 1012

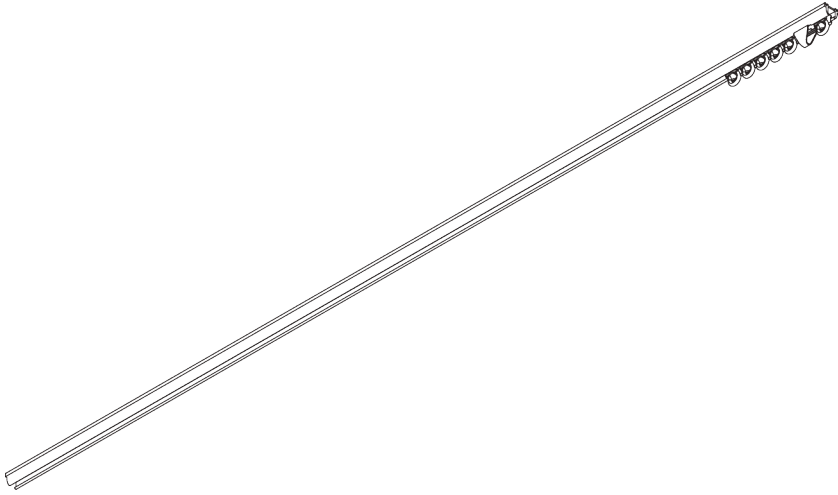

PRODUCT INFORMATION

- **Operation:** hand
- **Range:** S
- **Fitting:** ceiling (center SG 7550)
- **Colours:** white RAL 9016 or anodised aluminum, special colours possible
- **Fabrics:** refer to Silent Gliss fabric collection

Features:

- Pre-drilled profile
- Bendable

SYSTEM SPECIFICATIONS

A. PROFILE

Profile and bending information

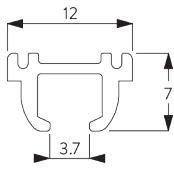

SG 1012p

Profile

Radius:
6 cm, 10 cm

B. HOW TO MEASURE

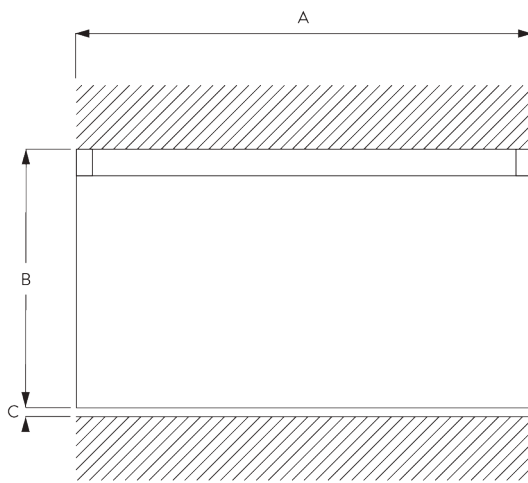

A: System width

B: System height

C: Distance between floor and fabric

FITTING

A. FITTING INFORMATION

For detailed fitting information, visit the [Silent Gliss website](#).

Fixing points

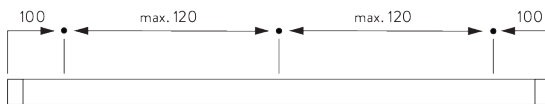

Profile Protector

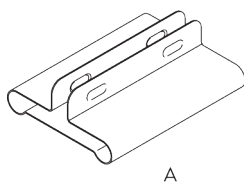

A: Profile Protector SG 7002

B: Special Screw SG 3019 / 12 mm

C: Special Screw SG 3025 / 18 mm

B. CEILING FITTING

Direct into wood

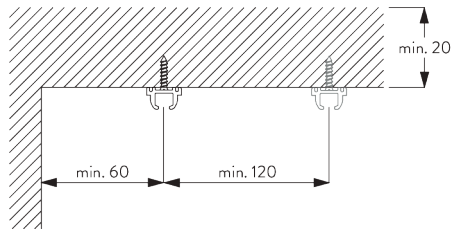

Bracket SG 3112

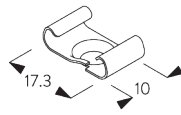
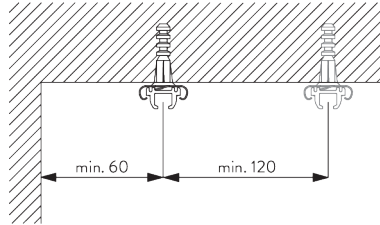

SG 3112

Bracket

Bracket SG 3121

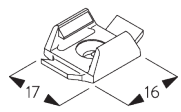
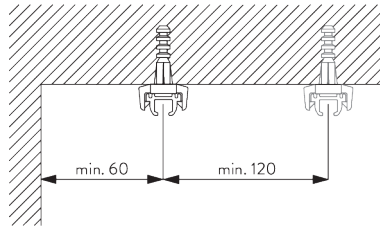





SG 3121



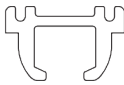







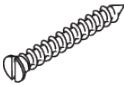

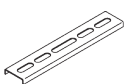
Bracket

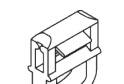
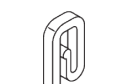
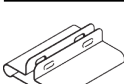

PARTS

A. STANDARD PARTS

	SG 1012p Profile
	SG 3019 Special screw 12 mm
	SG 3070 End stop
	SG 3085 Spring stop
	SG 3533 Glider

B. OPTIONAL PARTS

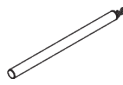
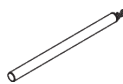
	SG 3025 Special screw 18 mm
	SG 3032 Spring stop
	SG 3064 Connecting bridge
	SG 3112 Bracket
	SG 3512 End cover
	SG 3534 Glider 3533 on strip
	SG 3535 Glider
	SG 3537 Glider
	SG 3548 Glider
	SG 3582 Hook
	SG 7002 Profile protector
	SG 10430 Draw rod 50 cm
	SG 10431 Draw rod 75 cm
	SG 10432 Draw rod 100 cm

	SG 10433 Draw rod 125 cm
	SG 10434 Draw rod 150 cm
	SG 11335 End stop