

SG 4740

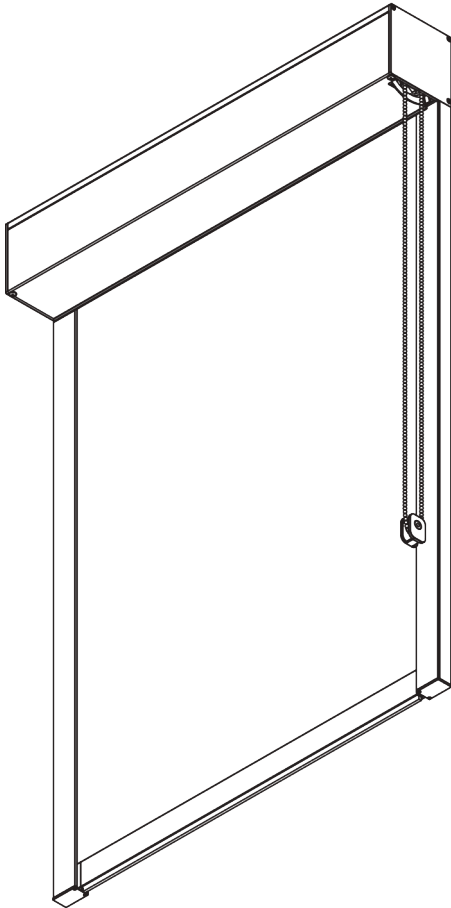
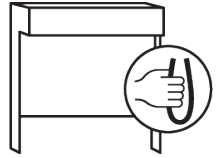

PRODUCT INFORMATION

- **Operation:** chain
- **Range:** L
- **Fitting:** ceiling, wall, recess
- **Colours:** white RAL 9016 or black RAL 9005, special colours possible
- **Fabrics:** refer to Silent Gliss fabric collection

Features:

- Zip technology
- Stainless steel bead chain
- 2-to-1 gear drive
- 40 mm side channel, pre-drilled fixing points

SYSTEM SPECIFICATIONS

A. SYSTEM DIMENSIONS



3 m

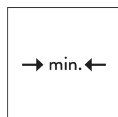

65 cm

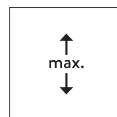

3 m

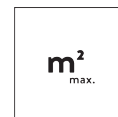

9 m²



6 kg

B. PROFILE

Profile information

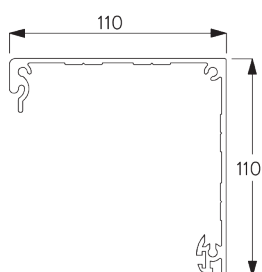

SG 10998

Box case 110 mm



SG 10999

Box cover 110 mm

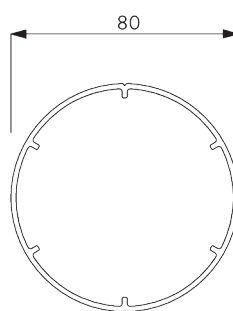

SG 11003

Tube ø 80 mm

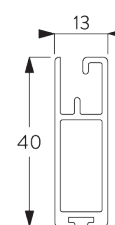

SG 10993

Bottom bar

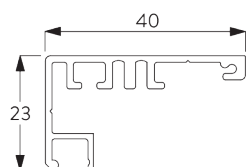

SG 11418

Side guide case

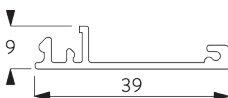

SG 11419

Side guide cover

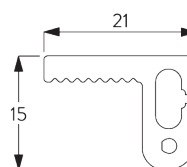

SG 11421

Zip profile

**C. HOW TO
MEASURE**

Inside fitting

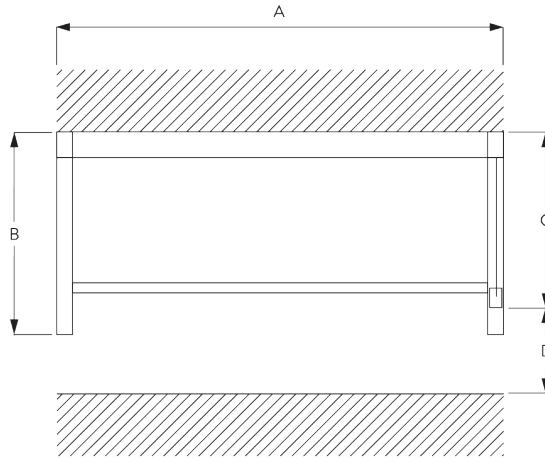

- A: System width
- B: System height
- C: Chain height
- D: Safety Retainer SG 10731 min. 150 cm above floor

Face fitting

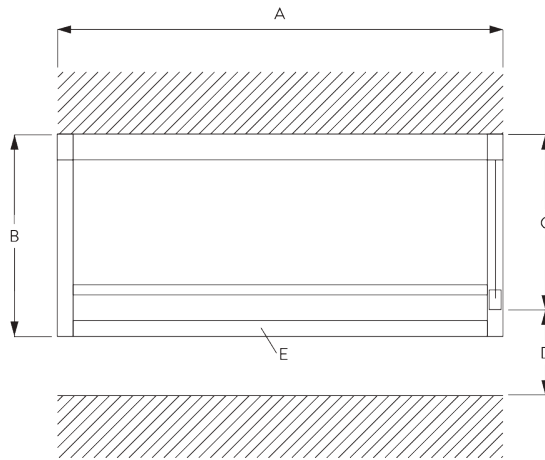

- A: System width
- B: System height
- C: Chain height
- D: Safety Retainer SG 10731 min. 150 cm above floor
- E: Optional: end profile (SG 11418 / SG 11419)

FITTING

**A. FITTING
INFORMATION**

For detailed fitting information, visit the Silent Gliss website.

Inside fitting - fixing points

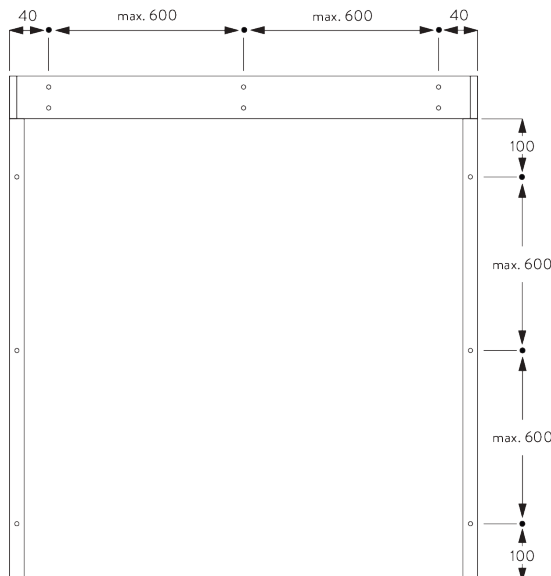

Face fitting - fixing points

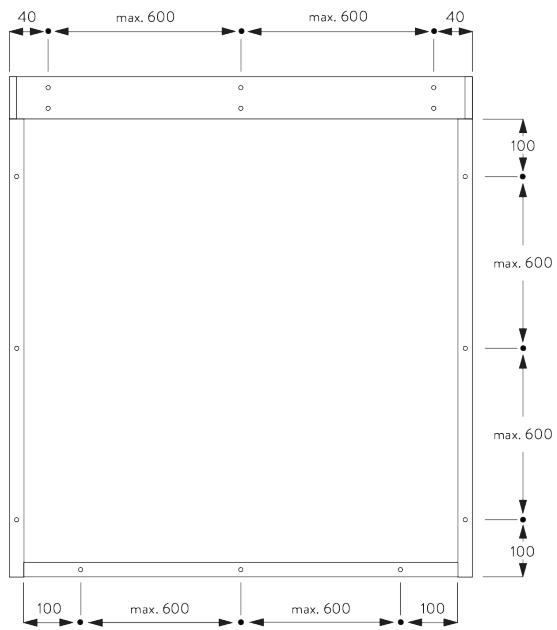

B. CEILING FITTING

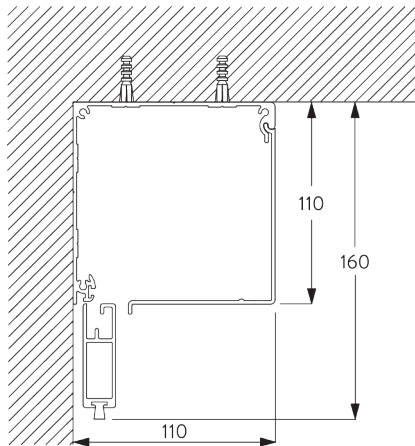

C. WALL FITTING

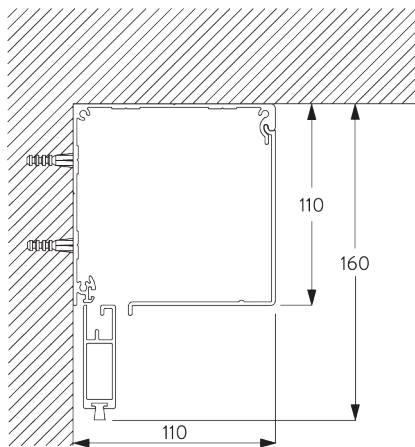

D. RECESS FITTING

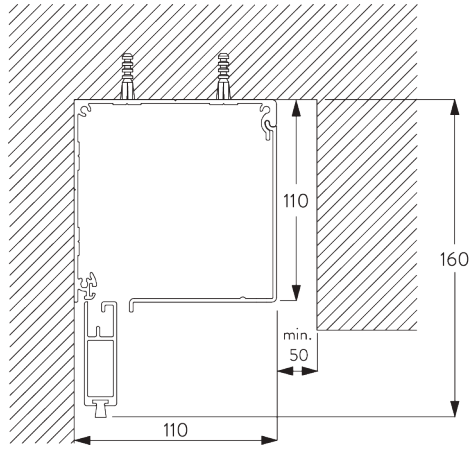

E. SIDE PROFILES
SG 11418 / SG 11419

Inside fitting

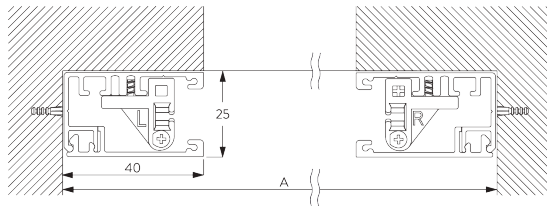

A: System width



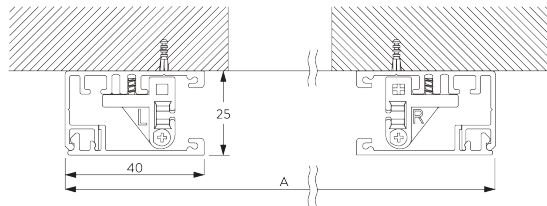







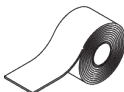

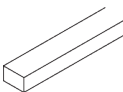
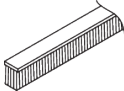

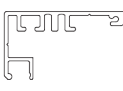
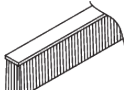

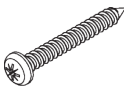

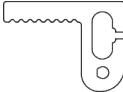
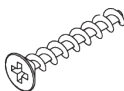
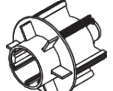
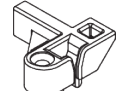
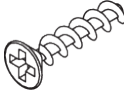
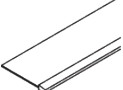

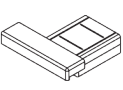
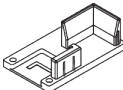
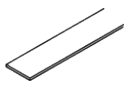
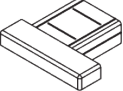
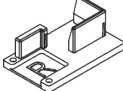
Face fitting

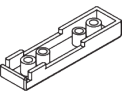
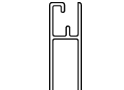

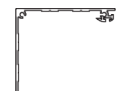
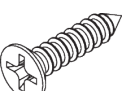
A: System width

PARTS

A. STANDARD PARTS

	SG 4226 Double tape 30 mm		SG 11009 End cover right 110 mm		SG 11060 Foam tape adhesive
	SG 4508 Brush 5x7 mm		SG 11011 Clip		SG 11418 Side guide case
	SG 4509 Brush 5x12 mm		SG 11012 Clip		SG 11419 Side guide cover
	SG 6791 Pan head screw 3.9x32		SG 11020 Tube adapter		SG 11421 Zip profile
	SG 6933 PT Countersunk screw KA25x16		SG 11021 Tube adapter		SG 11473 Zip guide left
	SG 6936 PT Countersunk screw KA22x10		SG 11025 Zip		SG 11474 Zip guide right
	SG 6942 Pan head screw KA30x8		SG 11028 End cover left		SG 11475 Side guide end cover left
	SG 10668 PVC strip 10 mm		SG 11029 End cover right		SG 11476 Side guide end cover right
	SG 10731 Child safety retainer set		SG 11030 Cover		
	SG 10993 Bottom bar		SG 11033 Chain drive		
	SG 10998 Box case 110 mm		SG 11034 Countersunk head screw 3.5x16		
	SG 10999 Box cover 110 mm		SG 11035 Countersunk head screw 2.2x9.5		
	SG 11003 Tube ø 80 mm		SG 11040 Bead chain ø 4.5 mm		
	SG 11008 End cover left 110 mm		SG 11059 Pan head screw with flange M4x12		

B. OPTIONAL PARTS

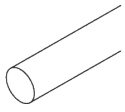

SG 4951

Bottom weight ø 8 mm



SG 11052

Spring left



SG 11053

Spring right

