

SG 1014

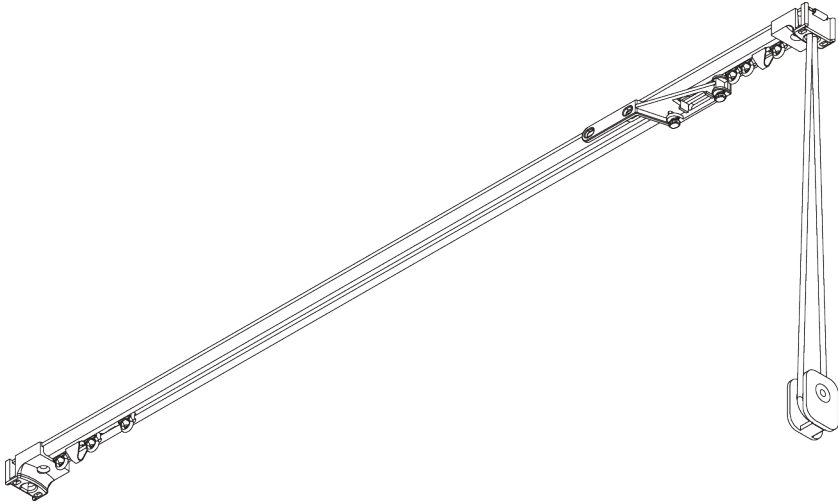

PRODUCT INFORMATION

- **Operation:** cord
- **Range:** S
- **Fitting:** ceiling
- **Colours:** white RAL 9016 or anodised aluminum, special colours possible
- **Fabrics:** refer to Silent Gliss fabric collection

Features:

- Pre-drilled profile
- Bendable
- Fitting tool center SG 7550

SYSTEM SPECIFICATIONS

A. SYSTEM DIMENSIONS

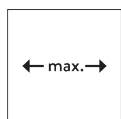

6 m



11 kg

Max. curtain weight

	2 m	4 m	6 m
	8	7	6
	11	10	8
	5	4	-
	6	5	-
	3	2	-
	5	4	-
	(kg max.)		

B. PROFILE

Profile and bending information

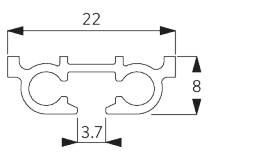

SG 1014p

Profile

Radius:
20 cm

C. HOW TO MEASURE

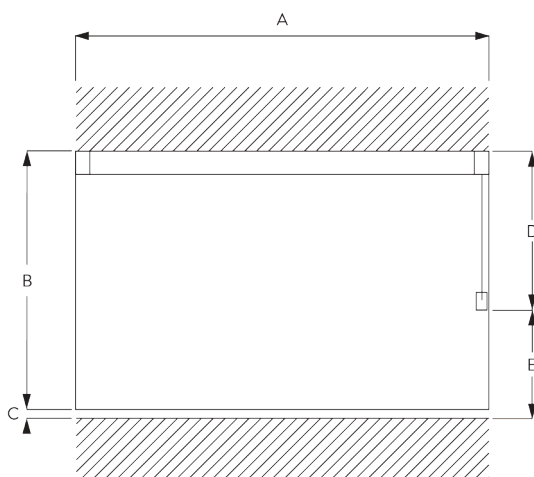

- A: System width
- B: System height
- C: Distance between floor and fabric
- D: Cord height
- E: Safety Retainer SG 10731 min. 150 cm above floor

FITTING

A. FITTING INFORMATION

For detailed fitting information, visit the Silent Gliss website.

Fixing points

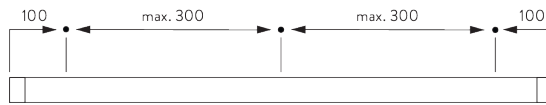

Fitting Tool

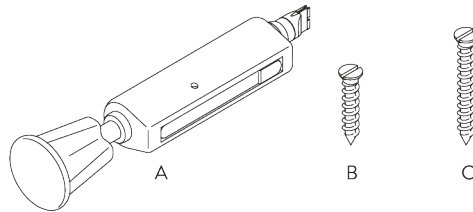

A: Center SG 7550 Tool
B: Special Screw SG 3019 / 12 mm
C: Special Screw SG 3025 / 18 mm

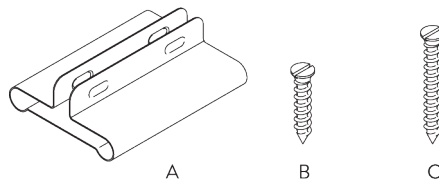

A: Profile Protector SG 7002
B: Special Screw SG 3019 / 12 mm
C: Special Screw SG 3025 / 18 mm

B. CEILING FITTING

Direct into wood

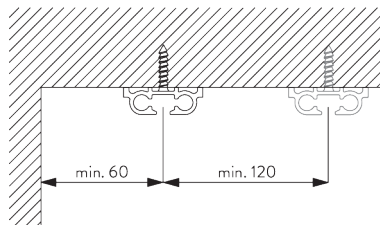

Bracket SG 3114

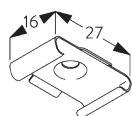
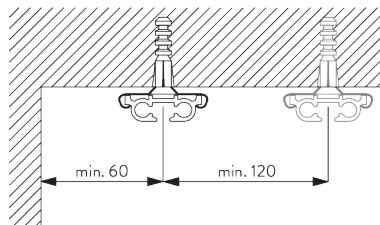

SG 3114
Bracket

PARTS

A. STANDARD PARTS

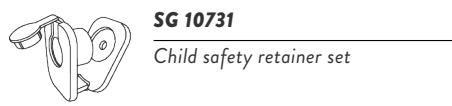
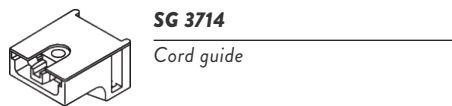
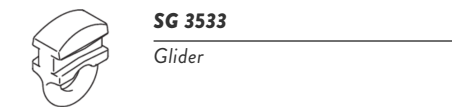
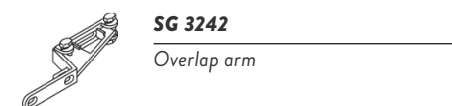
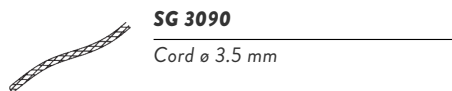
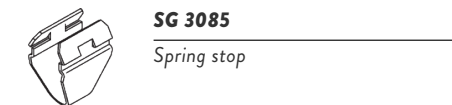
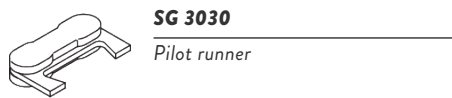
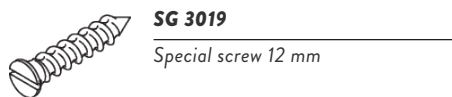
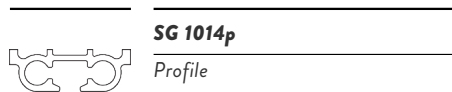

B. OPTIONAL PARTS

